

ZIVA®-Z 014 / -G 015 - Overview



Your High Level Butterfly Valve. Made for Industry.

- ▶ Butterfly Valve
- ▶ Z – wafer type
- ▶ G – lug type
- ▶ DN25/32 – DN600
- ▶ PN6 - PN16
- ▶ Temperature -10°C to 150°C
- ▶ Soft sealing
- ▶ Maintenance-free
- ▶ Good flow characteristic due to excellent Zeta-values
- ▶ Straight through spindle with 3 supports
- ▶ changeable lining
- ▶ Body detachable
- ▶ Spindle blow out protection
- ▶ Shaft / disc connection not in contact with the medium
- ▶ Body material
- ▶ EN-JS 1049
- ▶ Complete insulation possible according to german “Energy saving order – EnEV”
- ▶ Slip on flange DIN EN 1092-1
- ▶ Electric and pneumatic actuators

ZIVA®-Z 014 / -G 015 - Details



Replaceable liner

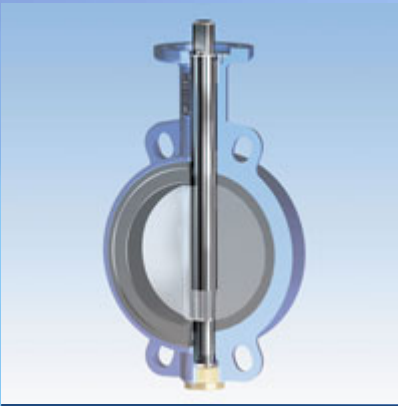

High strength (continuous shaft) provides operational safety



Blow out protection

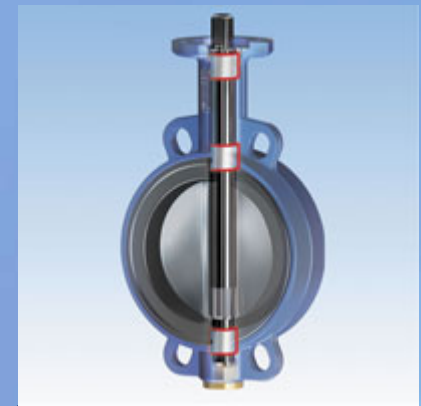

Your cost efficiency: Triple shaft (cylinder liners); operational shaft safety gives long service life

ZIVA®-Z 014 / -G 015 - Variants

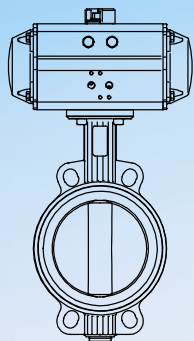

► 014 - with pneumatic part-turn actuator AIR TORQUE

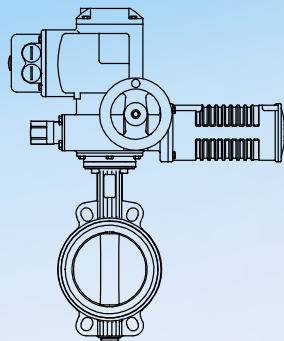

► 014 - with electric rotary actuator Auma

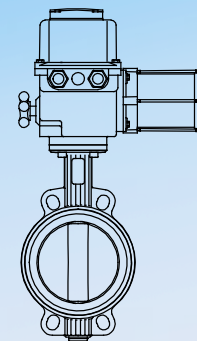

► 014 - with electric rotary actuator Deufra

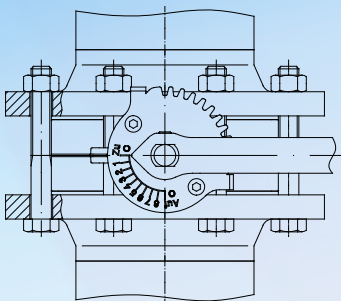

► 014/015 - with lock lever

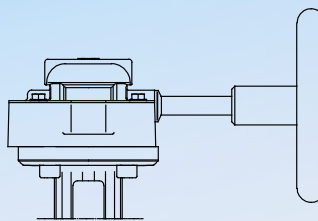

► 014/015 – with worm gear

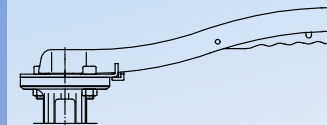

► 014/015 - with notch lever

ZIVA®-Z 014 / -G 015 - Variants

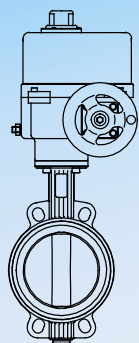

▶ 014 - with electric rotary actuator Rotork

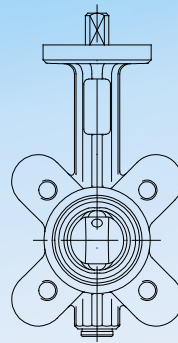

▶ 015 – DN 25
lug type butterfly valve

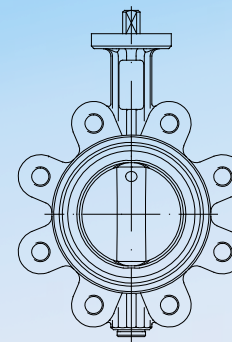

▶ 015 – DN 80
lug type butterfly valve

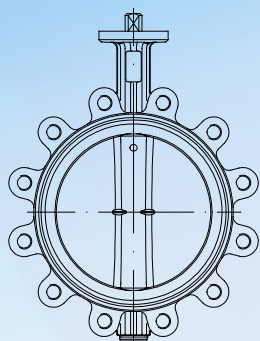

▶ 015 – DN 200
lug type butterfly valve

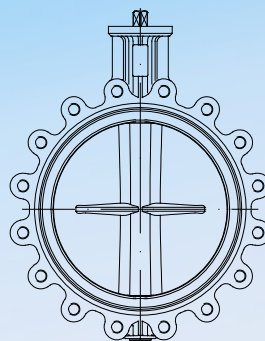

▶ 015 – DN 350
lug type butterfly valve

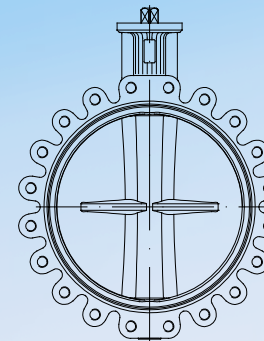

▶ 015 – DN 500
lug type butterfly valve